

Power Switching Subcircuit

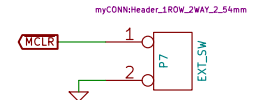

Power Input

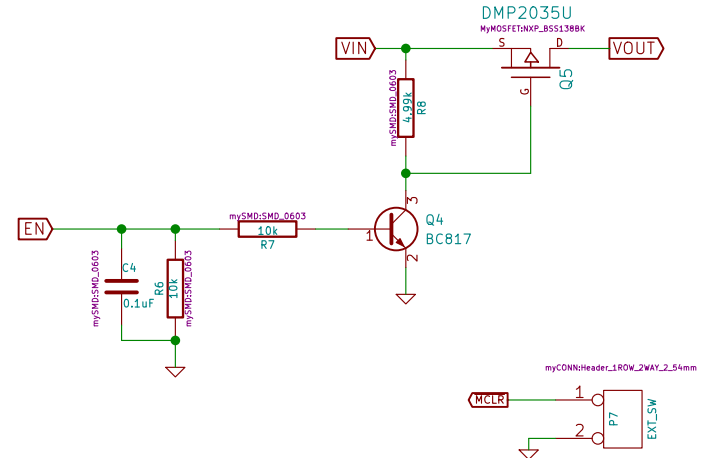
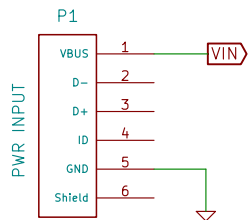
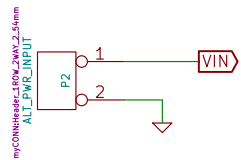

Power Output & GPIOs

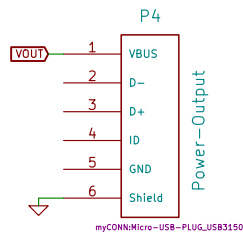
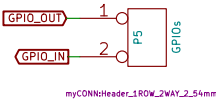
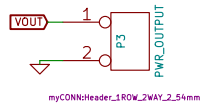

YEPKIT

Sheet: /
File: ykrud2.sch

Title: YKRUD 2

Size: A4

Date:

Yepkit Lda

Rev: 0.1.0

Id: 1/1